

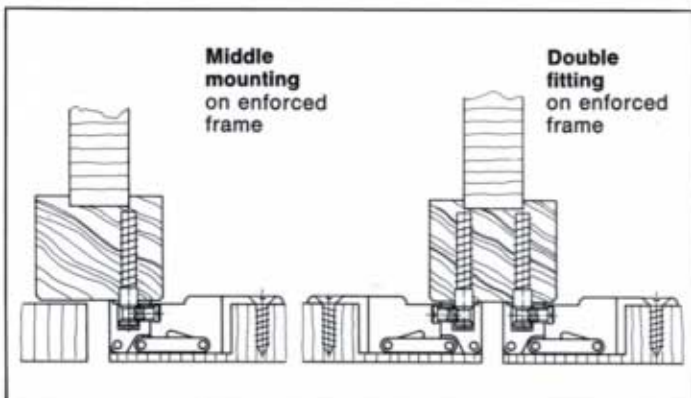

Quick mounting cabinet hinges

580-16/N
580-16/Go
580-16/Si

580-19/N
580-19/Go
580-19/Si

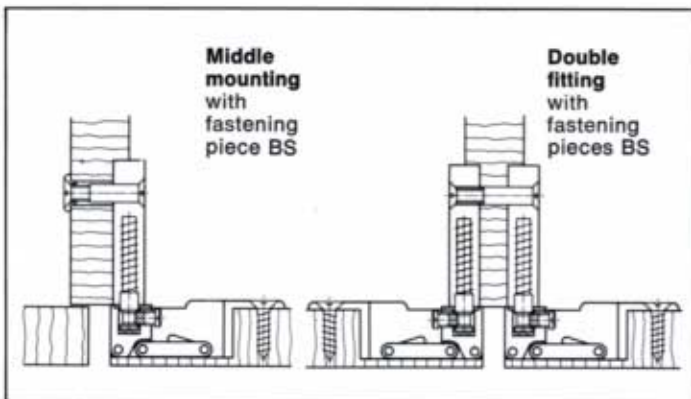
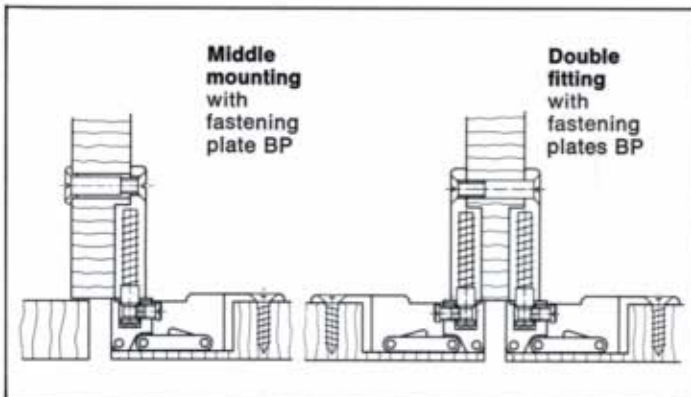
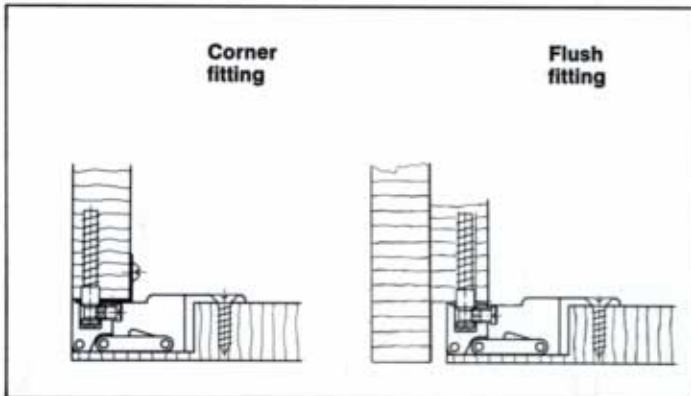

Fitting: invisible
Opening angle: 100°
Finish: all metal
Colour: N = bright nickel plated
Go = gold-colour heat lacquered
Si = silver-colour heat lacquered
Wood thicknesses 580-16 from 16 mm = 5/8" upwards
580-19 from 19 mm = 3/4" upwards
Joints 3 mm upwards (see list over-leaf)
Depth and side adjustable, detachable
Package: 20 pieces

Fitting instructions and fitting tools

Page 6 + 7

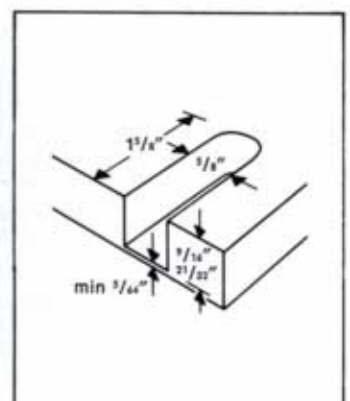

Measurements and weights of doors:

Height		Width		Weight		Number hinges
cm	in.	cm	in.	kg	lbs.	
200	80	62.5	24	20	45	3
160	60	62.5	24	16	35	3
120	50	62.5	24	12	25	3
80	30	62.5	24	8	18	2
50	20	50.0	20	4	9	2

Doors should not be wider than high.
Min. distance of hinges on small doors should be 40 cm = 15 inches.

Reading of tenders (Example for ordering)
PRAMETA quick mounting cabinet hinges
580-16/N
580-16/Go
580-16/Si
PRAMETA quick mounting cabinet hinges
580-19/N
580-19/Go
580-19/Si

Fastenings of frame and accessories see over-leaf

Quick mounting cabinet hinges





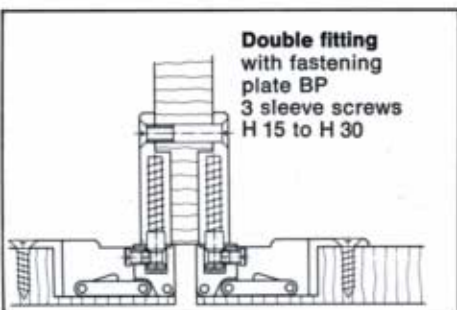
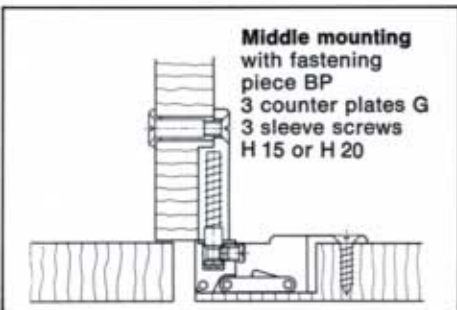
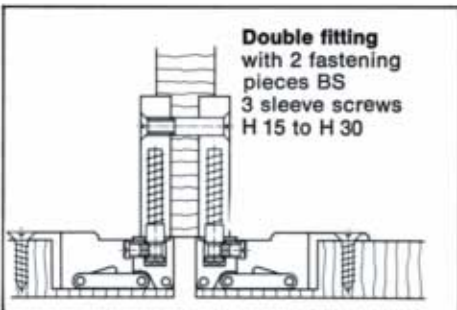
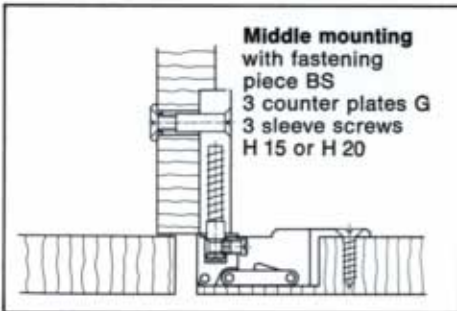
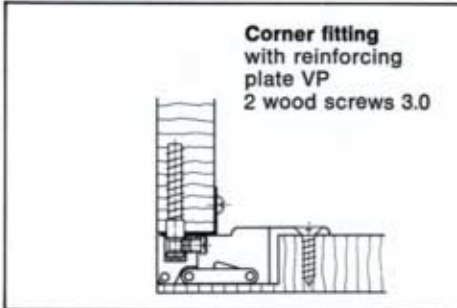

580-16/N
580-16/Go
580-16/SI

580-19/N
580-19/Go
580-19/SI

Fastenings on frame



Accessories

	Designation	Package	Use
	Fastening plate BP white or brown	20 pieces	Joint is determined by thickness of frame Single and double fitting on middle frames
	Fastening piece BS white or brown	20 pieces	Joint determined by depth of drilling "d"
	Reinforcing plate VP	100 pieces	Additional reinforcement of threaded bolt in particle board 
	Counter plate G	50 pieces	For through-going fastening on frame
	Sleeve screw H 15 to H 40	50 pieces	For through-going fastening on frame

Fitting tool

	Template drill set B 580	1 set = 3 pieces	Exact positioning of hinge from door to frame
---	--------------------------	---------------------	---

Schedule of joints

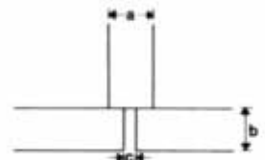
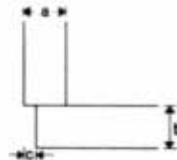

Side movement on single doors

Thickness of frame "a"		Thickness of door "b"		Joint "c"			
mm	in.	mm	in.	580-16		580-19	
15-22	19/32-7/8	16	5/8	3	1/8		
16-22	5/8 -7/8	17	43/64	4	5/32		
17-22	43/64-7/8	18	45/64	5	13/64		
18-22	45/64-7/8	19	3/4	6	15/64		
15-22	19/32-7/8	19	3/4			3	1/8
16-22	5/8 -7/8	20	25/32			4	5/32
17-22	43/64-7/8	21	53/64			5	13/64
18-22	45/64-7/8	22	7/8			6	15/64

Necessary joints on double doors

Thickness of frame "a"	Door thickness "b"		Joint "c"			
	mm	in.	580-16		580-19	
Frame thickness and trimming depth: see mounting instructions	16	5/8	6	15/64		
	17	43/64	8	5/16		
	18	45/64	10	25/64		
	19	3/4	12	15/32		
Fastening plate BP Fastening piece BS	19	3/4			6	15/64
	20	25/32			8	5/16
	21	53/64			10	25/64
	22	7/8			12	15/32

Instructions for use

Determine drillings in frame

- Adjust joint on template drill B 580.
- Put door on frame, consider base for template drill and pull tight.



Example for template drill set B 580 for quick mounting cabinet hinge 580.

Drill in frame

Push template drill into drilling and drill $\phi 5,2 \times 30 \text{ mm} = 13/64" \times 3/16"$ deep

Tool

Drill bit $\phi 5,2 \text{ mm} = 13/64"$
 – available from specialized dealers –
 PRAMETA tool set
 1 set = 3 pieces template drills B 580

Mass production

Screw template drills on wood board.
 Mount drill sets on trimming templates
 $\phi 8 \text{ mm} = 5/16"$.

Fitting tool

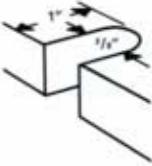
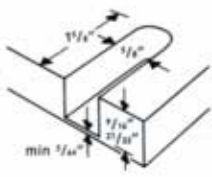
		for quick mounting cabinet hinges	with trimming of door edge
	Template drill set B 580	510-19	
		580-16 580-19	

Handling



510

Mount door

Push hole in upper hinge on threaded bolt.
 Fasten clamping screw.
 Push in middle and lower hinges and fasten adjusting screw.

Depth adjustment

Turn threaded bolt out of or into frame.

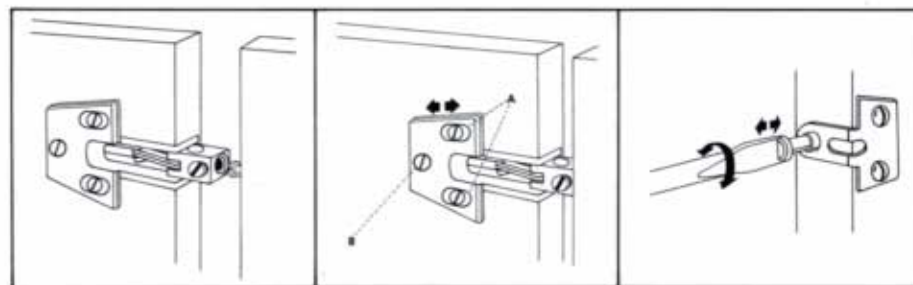

580

Mount door

Push hole in upper hinge on threaded bolt.
 Fasten clamping screw.
 Push in middle and lower hinges and fasten adjusting screw.

Side adjustment

Release adjusting screw A at flange, position flange into slots and tighten screws again.
 Then fasten screw B.

Depth adjustment

Turn threaded bolt out of or into frame.